

SYSTEM OVERVIEW

The Telesis® EY6DS is an advanced, fiber-coupled diode pumped solid state (DPSS) laser marking system. The laser beam and Q-switched pulse characteristics are optimized for applications that require high beam quality and stability. The EY6DS does an exceptional job of high speed marking on delicate and sensitive electronics components and medical instruments. Its short pulse width and extremely small spot size provide high resolution marking with minimal heat impact to surrounding areas. These characteristics make it an ideal choice for general-purpose laser marking, scribing, trimming, and other material processing applications.

The unique L-shaped design of the EY6DS features a Q-switched Nd:YAG end-pumped laser with a remote fiber-coupled diode pump source. With an average diode MTTF of 500,000 working hours, the EY6DS offers the user “best-in class” reliability.

The robust mechanical and optical design allows the Telesis EY6DS to operate in an industrial environment where shock, vibration, and dust are a concern.

The laser marking system offers these advantages:

- Reliable, long, maintenance-free performance
- Compact size and modular construction
- Remote, fiber-coupled pump diode
- Exceptional beam quality and stable output power
- Visible red aiming diode
- Air cooling
- Thermo-electrical temperature control of the laser crystal and pump diode
- Active AO Q-switching
- Standard 115/230VAC operation
- Large digital display for marker status, settings, and error condition monitoring
- Key switch, Laser Off button, interlocked safety shutter, and emission indicators
- DoD-compliant Unique Identification (UID) marking

SYSTEM CONFIGURATION

The EY6DS is available in several configurations. The system computer, required for running the Merlin® II LS software, may be an external device connected to the laser controller, or embedded within the laser controller itself. Additionally, the system may be configured to mark only stationary objects or to mark objects while they are moving (i.e., mark-on-the-fly).

The modular design allows for major components to be easily replaced and returned to Telesis if required. The basic laser system consists of the following components.

- **Laser Marking Head** – contains sealed resonator, beam expander, turning mirror, galvanometer assembly, visible red aiming diode.
- **Laser Controller** – contains pump diode, RF driver, and other electrical components
- **Fiber Optic Cable**
- **Cable Assemblies** – power, control, and data cables
- **Software** – Merlin II LS Laser Marking Software
- **System Computer** – may be an external device connected to the laser controller or embedded within the laser controller itself. If external, the computer may be supplied by Telesis or by the customer.
- **Monitor, Keyboard, and Mouse** – supplied by Telesis for systems with embedded computers; may be supplied by Telesis or by the customer for systems with external computers.

EY6DS Laser Marking System

SYSTEM SPECIFICATIONS

Compliance	CDRH
Laser Type.....	fiber-coupled, diode-pumped, Q-switched, Nd:YAG
Wavelength	1064 nanometers (nm)
Mode.....	TEM ₀₀
Long Term Output	
Power Drift.....	< ± 2%
Laser Diode MTTF	500,000 hours
System Power (total).....	< 500 watts
Power Requirements	115 VAC, single-phase, 9.0A, 50/60Hz
	230 VAC, single-phase, 4.5A, 50/60Hz
Maximum Supply Voltage	264 VAC
Supply Voltage Fluctuation	< ±10% with clean ground line
Operational Temperature	18° to 35°C (65° to 95°F)
Recommended Temp.....	20° to 25°C (68° to 77°F)
Ambient Relative Humidity....	10% to 85% non-condensing

SYSTEM OPTIONS

- External computer (desktop or notebook with powered cardbus-to-PCI expansion enclosure) to run the Merlin II LS Laser Marking Software
- Embedded computer within the laser controller to run the Merlin II LS Laser Marking Software
- Laser Controller Fuse/Connector Kit
- Remote pushbutton station (start/abort)
- Externally-mounted focus-finder diode
- Mark-on-the-fly kit to interface with customer-supplied encoder for marking objects in motion (linear or circular)
- I/O options (see *Remote Communications* for details):
 - TTL via PCI-DIO24 Board
 - Opto-isolated via Merlin DCIO Module
 - Two-axis Controller
- Manually operated tool post for vertical (z-axis) adjustment
- Programmable tool post for vertical (z-axis) adjustment (requires two-axis controller)
- Rotary drive fixture for rotational (theta-axis) adjustment (requires two-axis controller)
- Workstation / work area enclosure
- Fume extraction systems

SYSTEM SETUP

The following procedures are listed for reference only to provide a general overview of the installation process. Refer to the *EY6DS Installation & Maintenance Manual* for complete installation details.

Do not connect any power cable to power source until all system connections are made.

1. All equipment must remain powered down and in the OFF position until mounting and connections are complete.
2. Place the laser controller, monitor, keyboard, mouse, and if applicable, the external system computer, in the desired locations. Locate the laser controller as close as practical to the laser marking head.
3. Ensure sufficient clearance exists on all sides of the laser controller to allow for proper air circulation and to permit proper installation of applicable cables. Refer to the *E1015 Laser Controller Dimensions* drawings for details.
4. Place the laser marking head on a suitable mounting surface.
5. Ensure sufficient clearance exists on all sides of the laser marking head to allow for proper air circulation and to permit proper installation of applicable cables.
6. Mount the laser marking head with a minimum of three M5-0.80 bolts and lock washers using the factory-tapped mounting holes provided. Refer to the *EY6DS Laser Marking Head Dimensions* drawing for details.
7. Connect all cables as applicable (fiber optic cable, laser marking head cable, RF cable, galvo control cable, computer monitor, keyboard, and mouse).
8. Connect any optional or customer-supplied devices or interface circuits as applicable.
9. Refer to the *EY6DS Operation Supplement* for proper startup procedure. Refer to the *Merlin II LS Operating Instructions* for complete information on using the system software.

EY6DS Laser Marking System

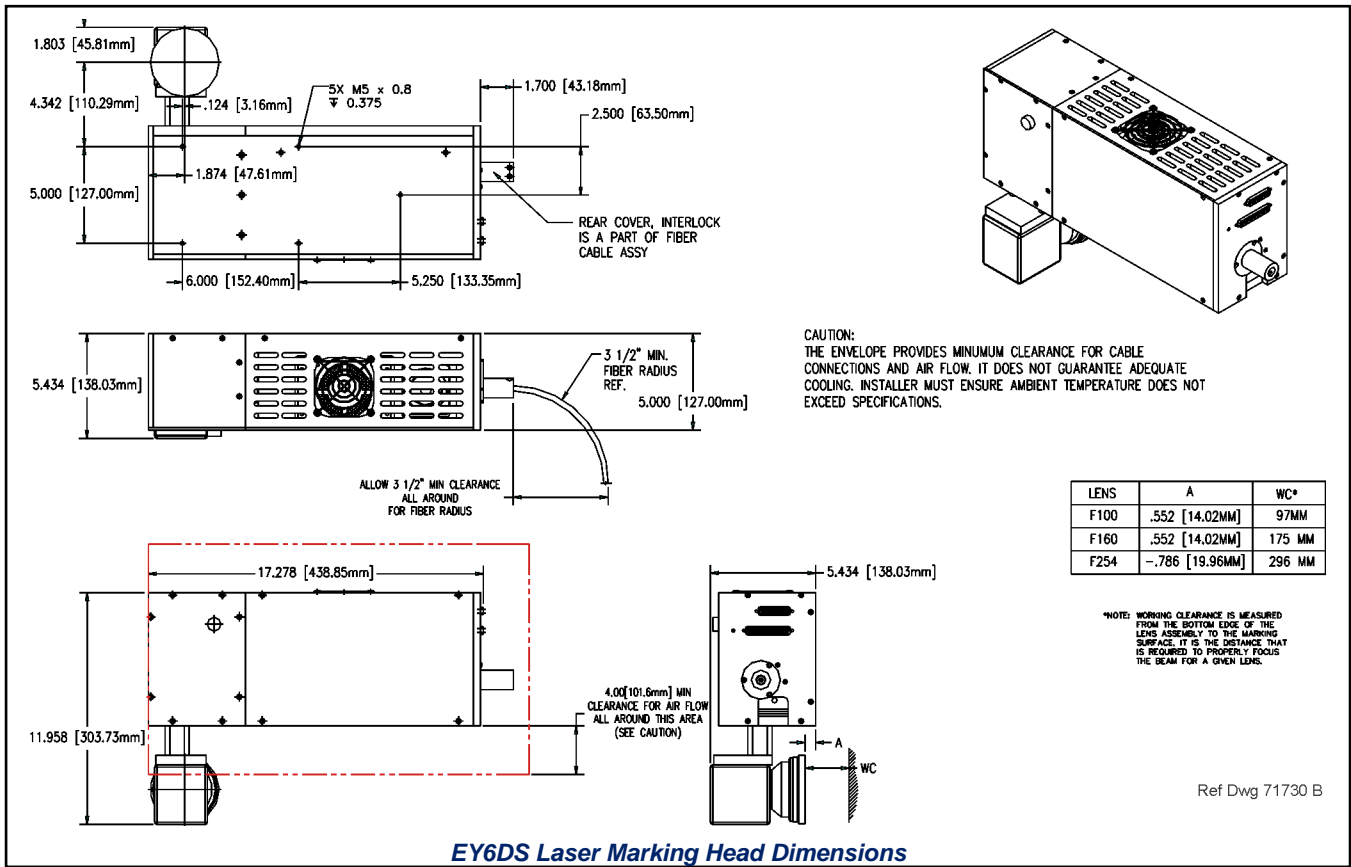

EY6DS Laser Marking Head Dimensions

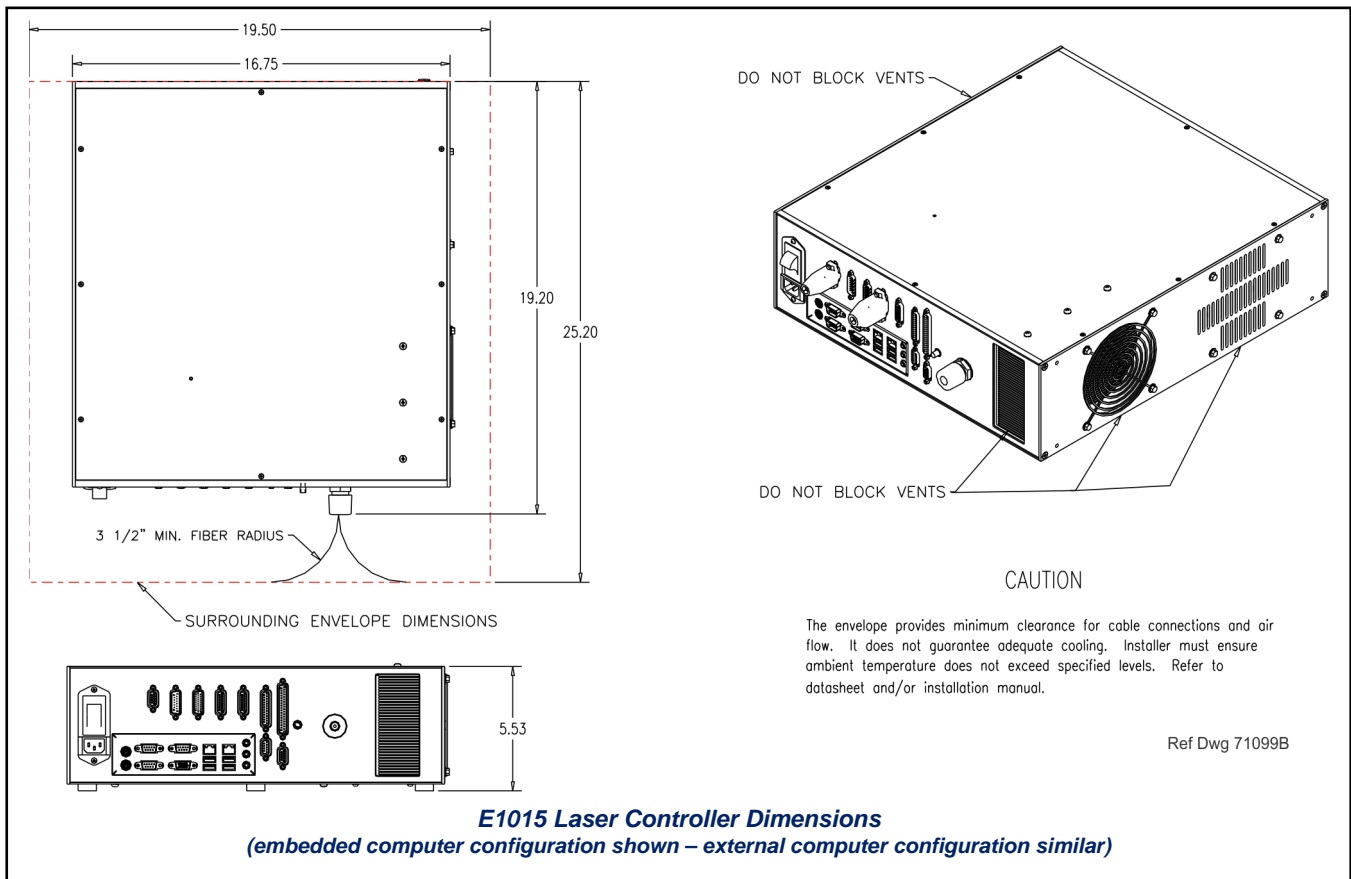

E1015 Laser Controller Dimensions
 (embedded computer configuration shown – external computer configuration similar)

EY6DS Laser Marking System

EY6DS LASER MARKING HEAD SAFETY LABELS

The following illustration shows the labels and their locations on the EY6DS laser marking head. Please familiarize yourself with the laser labels and their locations prior to operating the laser marking system.

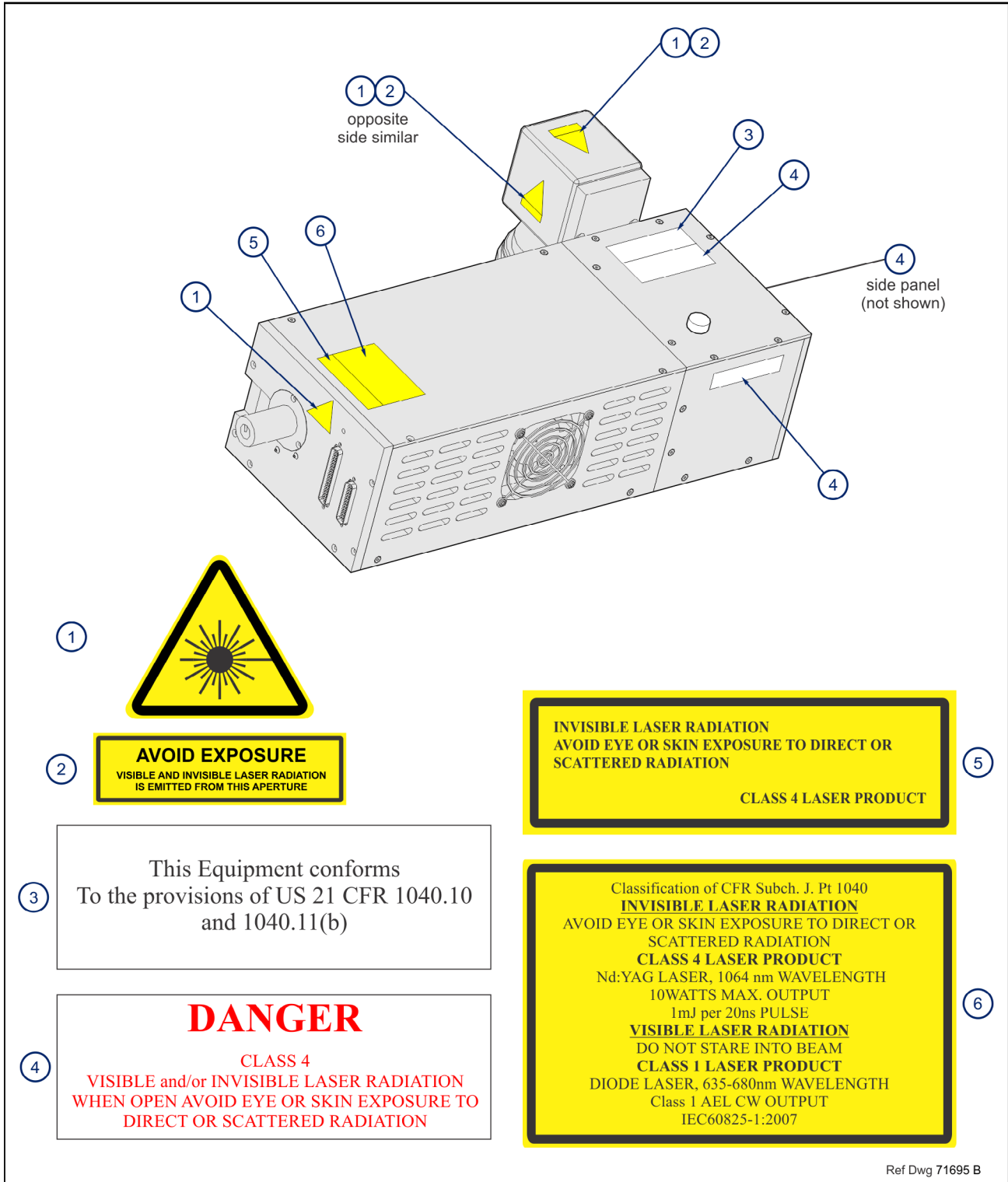

Ref Dwg 71695 B

E1015 LASER CONTROLLER SAFETY LABELS

The following illustration shows the labels and their locations on the E1015 laser controller. Please familiarize yourself with the laser labels and their locations prior to operating the laser marking system.

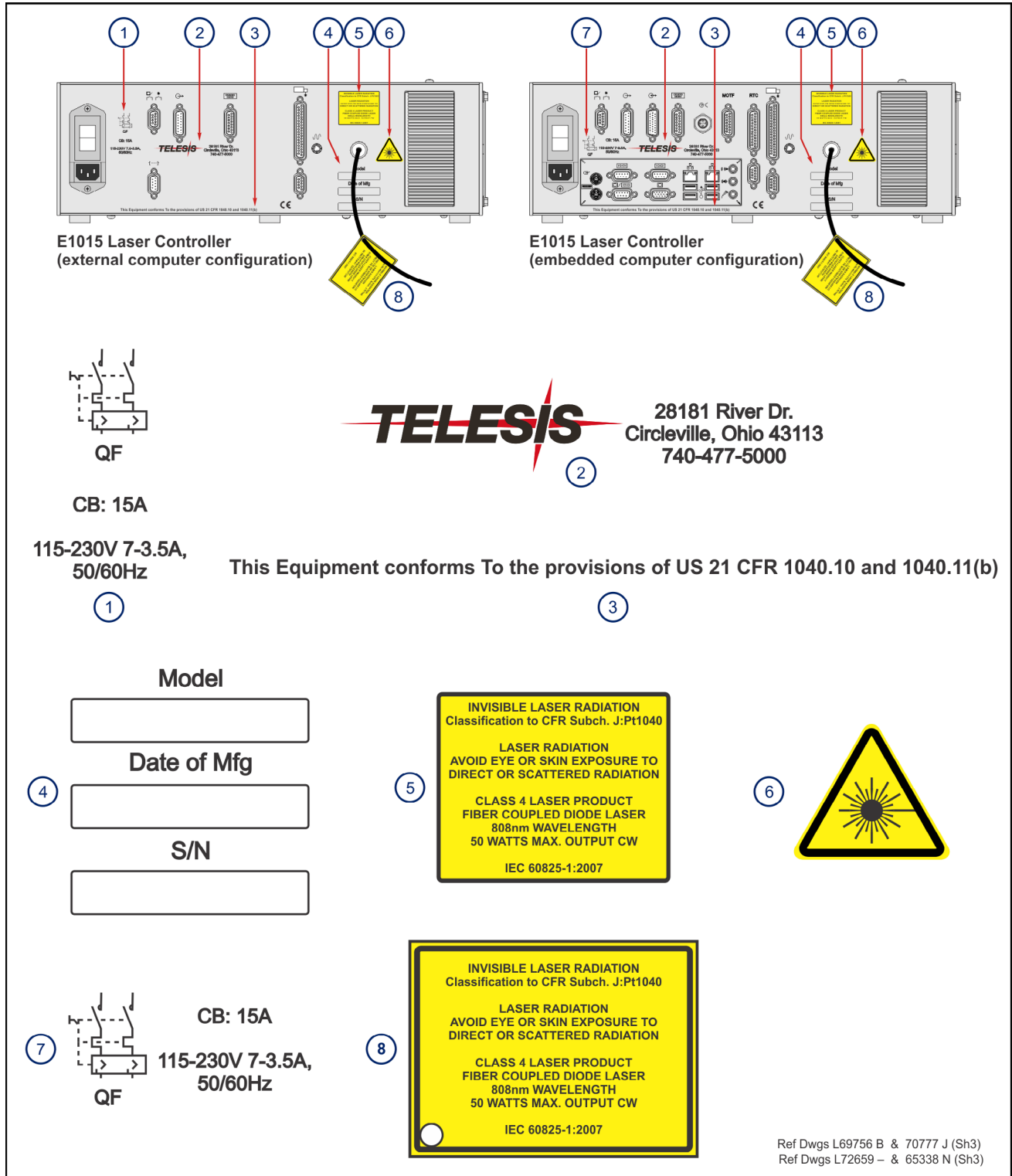

EY6DS Laser Marking System

EY6DS LASER MARKING HEAD

The EY6DS has a unique, space-saving “L” shaped footprint. Designed for easy maintenance, the galvo head is mounted at a 90° angle to the laser rail. A heat exhaust fan is located on the right side of the unit (as viewed from the connector panel).

The laser marking head encloses the sealed laser resonator, the beam expander, the turning mirror, the red aiming diode, and the galvanometer assembly.

EY6DS Laser Marking Head Specifications

Dimensions (L x W x H)	482.03* x 303.73 x 138.03 mm (18.978* x 11.958 x 5.434 in.)
Surrounding Envelope	see <i>EY6DS Laser Marking Head Dimensions</i> drawing
Mounting Weight	approximately 13.6 Kg (30 lbs.)
Mounting	five M5-0.80 mounting bolts
Positioning	visible (red) aiming diode
Field Resolution	16 bit (65535 data points)
Galvanometer	
Repeatability	< 22 micro radian
Marking Field Size	lens-dependent, see chart
Fiber Optic Cable Length	1.75 m (5.74 ft.) – standard 4.75 m (15.58 ft.) – optional
Cooling	air cooled, active thermo-electric

* Length includes rear panel interlock switch (part of fiber cable)

Dual-Sensor Shutter Circuit

The EY6DS laser marking head employs two separate sensors to detect the closed-state of the laser shutter mechanism. The sensor signals can be monitored at the Outputs Connector on the back panel of the laser controller. When the shutter is open, the sensor feedback signals are OFF. When the shutter is closed, the sensor feedback signals are ON.

Sealed Laser Resonator

The laser resonator is assembled and sealed in the clean room environment to prevent contamination. The laser marking head contains an electro-mechanical safety shutter. Under power, the safety shutter allows 1064nm laser beam to pass through the galvanometer steering mirrors. If the shutter is closed during normal operation (or power is removed from the system via a power off/stop condition) it will block the 1064nm laser beam.

Visible Red Aiming Diode

The laser marking head produces a visible red diode that may be viewed on the work surface without the need for protective safety goggles. This provides a safe and convenient aid for laser setup and part programming. Since the red beam is located *after* the shutter, the aiming diode may be used with the shutter opened or closed. Additionally, the visible red beam may be used with the lasing beam during the marking cycle. **Note that protective eyewear must always be worn when the laser is in operation.**

Marking Field Size

The size of the marking field is dependent on type of lens installed on the laser marking head. See *Flat-Field Lens*.

Marking Depth

Simple laser parameters can be operator programmed to create depths ranging from simple surface discoloration, shallow laser etching, or deep laser engraving. Marking depth is dependent on several factors including material, lens type selected, and laser marking parameters. Please contact Telesis for the proper setting for your specific application.

Flat-Field Lens

The flat-field lens is key to the marking performance of the system. This is the final coated optical lens that the beam will pass through before it strikes the marking target. This lens is called a flat field lens because when the beam is focused, the focus lies in a plane perpendicular to the optical axis of the lens. To protect the final objective lens from dust and debris, a clear protective cover is inserted between the work area and the lens.

The following chart outlines the available lenses, the resulting image field (marking window) provided by the lens, and the working clearance (in millimeters and inches) to properly focus the laser for marking.

Lens	Image Field		Working Clearance	
	(mm)	(in.)	(mm)	(in.)
100 mm	65 x 65	2.56 x 2.56	97	3.82
160 mm	110 x 110	4.33 x 4.33	175	6.89
254 mm	175 x 175	6.89 x 6.89	296	11.65

EY6DS Laser Marking System

E1015 LASER CONTROLLER

The pump diode is enclosed in the laser controller, while the laser resonator with the crystal is located in the laser marking head. The pump beam from the diode (approx. 808nm) is delivered through a fiber optic cable directly into the laser resonator. This compact laser controller can be fitted to any standard-rack mount or it can be placed directly upon a desktop.

The laser controller also contains the active thermo-electrical cooling system for the pump diode, the RF driver, galvanometer power supply, driver control circuits, appropriate fusing, and a 115/230VAC IEC320 connector, and a front panel control module.

Engineered for the greatest reliability and for ease of maintenance, the pump diode within the laser controller is an easily replaceable sealed module with an expected MTTF of 500,000 operating hours.

Fiber Optic Cable Assembly

The fiber optic cable is permanently attached to the pump diode within the laser controller and cannot be removed. The standard optical fiber is 1.75 meters (5.74 feet) long. An optional 4.75 meter (15.58 ft.) fiber optic cable is also available.

E1015 Laser Controller Specifications

Dimensions (W x H x D)	425.45 x 140.46 x 487.68 mm (16.75 x 5.53 x 19.20 in.)
Surrounding Envelope.....	see <i>E1015 Laser Controller Dimensions</i> drawing
Weight.....	approximately 15 Kg (33 lbs.)
Cooling.....	air cooled, active thermo-electric

Operator (Front) Panel

The front panel of the laser controller includes the system enable key switch, a soft power on/off button, green power indicator, laser start push button, laser off push button, safety shutter open and close controls, a laser on (emission) indicator, function indicators, and a liquid crystal display screen. The LCD screen allows monitoring of the diode current, the crystal and diode temperatures, the system status, and error conditions.

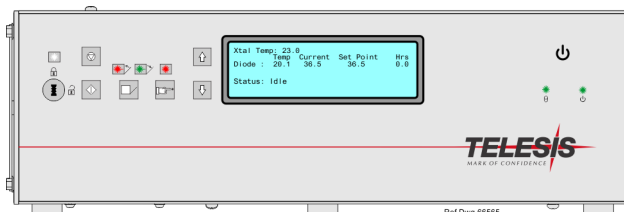

E1015 Laser Controller – Front Panel

Connector (Back) Panel for External Computer Usage

The rear panel of the laser controller provides a power entry module with circuit breaker and connectors for the fiber optic cable, laser marking head cable, galvo control cable, and RF cable. It also provides a remote interlock connector, a remote pendant connector, and an outputs connector. The outputs connector allows you monitor output signals reporting the status of the shutter, laser emission, and fault conditions.

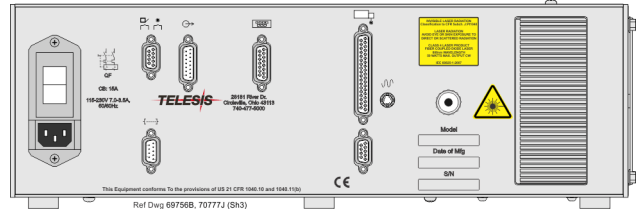

**E1015 Laser Controller
Back Panel – External Computer**

Connector (Back) Panel with Embedded Computer

The rear panel of the laser controller provides a power entry module with circuit breaker and connectors for the fiber optic cable, laser marking head cable, galvo control cable, and RF cable. It also provides a remote interlock connector and a remote pendant connector. An output connector allows you to monitor output signals reporting the status of the shutter, laser emission, and fault conditions.

An opto-isolated I/O connector and an I/O cable is provided for connection to the remote I/O devices. Refer to *Remote Communications* for more information.

Connections for the embedded system computer are mounted on a sub-panel. The separate panel allows you to connect a monitor, keyboard and mouse directly to the laser controller. Additional RS-232, Ethernet, and USB ports are provide for other optional connections and usage with Telesis software.

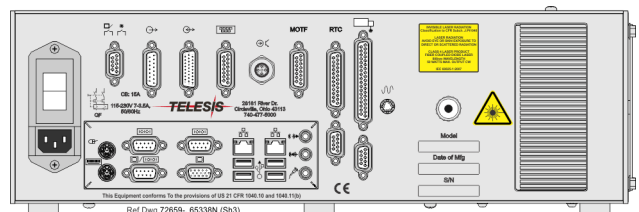

**E1015 Laser Controller
Back Panel – Embedded Computer**

EY6DS Laser Marking System

SYSTEM COMPUTER

The laser system requires an IBM-compatible computer for running the Merlin II LS Laser Marking Software. The system computer may be an external device connected to the laser controller, or it may be embedded within the controller itself.

NOTICE

Merlin II LS software and associated applications are pre-installed on the embedded computer. The embedded system supports Telesis-installed software only and does not support user-installed programs.

All system computers supplied by Telesis (external and embedded) have the laser/galvo controller board and the Merlin II LS software installed prior to shipment so the entire assembly is tested as a laser marking system. Warranties for the computer, keyboard, monitor, and peripherals default to the original equipment manufacturer.

If the external system computer is supplied by anyone other than Telesis it must use the following software:

Operating System Windows® 2000, XP, Vista® (Business), 7 (professional) or 8 (Professional)

Operator Interface.... Telesis Merlin II LS Laser Marking Software

Additionally the system computer must, at a minimum, meet the following specifications:

Processor Pentium® III with RAM as recommended per operating system

Hard Drive 2 GB Hard Disk Drive

External Drives CD-ROM Drive

Comm Ports One available RS-232 Serial Port,
Two available USB Ports,
Two available Ethernet Ports,
Two available full-height PCI Slots ¹

Circuit Cards Laser/Galvo Controller Board,
Video Board

Peripherals SVGA Color Monitor, Mouse²,
Keyboard²

¹) One additional PCI slot required if system is configured for mark-on-the-fly operation. If the system computer is a notebook, expansion must be used to provide the PCI slots.

²) Telesis recommends a USB mouse and a USB keyboard for system computers that are embedded in the laser controller.

SYSTEM SOFTWARE

The powerful Telesis Merlin II LS Laser Marking Software is a Windows® based software package that comes standard with the laser marking system. It is a graphical user interface that makes marking pattern design quick and easy. The WYSIWYG (what-you-see-is-what-you-get) interface provides a to-scale image of the pattern as it is created. Just “click and drag” for immediate adjustment to field size, location, or orientation.

The Merlin II LS software includes tools to create and edit text at any angle, arc text, rectangles, circles, ellipses, and lines. Multiple fields may be grouped and saved as a block to form a logo. Existing DXF files can also be imported for marking. Non-printable fields can be created to clearly display a graphical representation of the part being marked.

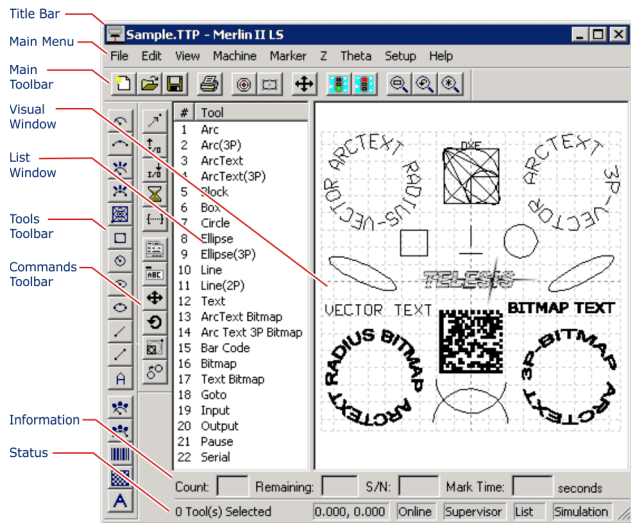

Merlin II LS User Interface

Merlin II LS Laser Marking Software Specifications

Operating System	Windows® 2000, Windows® XP, or Windows® Vista™ Business Edition
Font Generation	True Type Fonts
Barcodes and Matrix	2D Data Matrix, PDF417, BC 39, Interleaved 2 of 5, UPCA/UPCE BC 128, Maxi Code, Code 93, QR Code and others
Graphic Formats	Raster and Vector: BMP, GIF, JPG, WMF, EMF, DXF, CUR, ICO
Serialization	Automatic and Manual Input Host Interface Capable
Linear Marking	Scalable w/ Letter Spacing Control
Arc Text Marking	Scalable and Adjustable
Drawing Tools	Line, Rectangle, Circle, Ellipse

Remote Communications

The communication capability of the laser marking software allows you to control the laser from a remote source. Remote communications can be performed by connecting to a Host computer, an optional two-axis Auxiliary Controller, or to remote I/O devices.

Host Communications. Remote communications may be executed from a host computer using RS-232 or Ethernet (TCP/IP) connections to the system computer running the Telesis laser marking software. The software provides parameters to define the data transmitted to and from the host. For more information on using and configuring these parameters, refer to the *Merlin II LS Operating Instructions*.

Two-axis Controller. Telesis offers an optional two-axis controller for all laser systems that use the Merlin II LS Laser Marking Software. The auxiliary controller provides an interface for connecting a Z-axis tool post and/or a Theta-axis rotary drive unit. An optional board allows connection of two additional linear axes. For installation details, refer to the *Auxiliary Controller Installation & Maintenance Manual* supplied with the two-axis controller.

I/O Kits for Systems with External Computers. Telesis offers optional I/O kits that provide up to 12 additional, programmable I/O signals (6 inputs and 6 outputs). All kits provide an I/O card, pre-installed SIPs resistor packs, and software driver CD. For details on connecting and using the additional I/O signals, refer to the *Installation Supplement* provided in each of the kits.

- **Kit 53920** ⁽¹⁾ provides a PCI-DIO24 card.
- **Kit 53928** ⁽²⁾ provides a PCI-DIO24 card, the Merlin I/O Interface Module, and two cable assemblies.
- **Kit 74445** ⁽¹⁾ provides a PCIe-DIO24 card (PCIe x1).
- **Kit 53928** ⁽²⁾ provides a PCIe-DIO24 card (PCIe x1), the Merlin I/O Interface Module, and two cable assemblies.

- 1) *This kit does not provide opto-isolated signals. Telesis does not endorse direct connection of I/O signals to the I/O board. Direct connections to high current/high voltage devices will damage the board.*
- 2) *When using the Merlin I/O Interface Module in this kit, additional I/O racks or opto-isolated board assemblies are not required.*

I/O Connector for Systems with Embedded Computers.

Controllers configured with an embedded computer provide an opto-isolated DB26P I/O connector. Separate I/O racks or opto-isolated board assemblies are not required. In addition to the standard input signals (Go, Abort, Input 1 through Input 4) and standard output signals (Done, Ready, Paused, Output 1 through Output 3), this connector provides two programmable inputs and two programmable outputs. For more information on connecting and using the opto-isolated I/O connector, refer to the *EY6DS Installation & Maintenance Manual*.

Communications Protocol

Two types of host interface are supported (RS-232 or TCP/IP) and two communication protocols are provided through the Merlin II LS laser marking software: Programmable and Extended.

Programmable Protocol. Programmable protocol provides one-way (receive only) communication with no error checking or acknowledgment of the transmitted data. You may use Programmable protocol to extract a continuous portion of a message string to print. This can be used with a host computer or a bar code scanner. Note that XON/XOFF Protocol applies even when Programmable Protocol is selected.

The Programmable Protocol Message Type identifies the type of message sent from the host. It determines how the marker uses the data it extracts from the host message string when Programmable Protocol is used.

- 49 Message type 49** (ASCII I) overwrites the content of the first text-based field in the pattern with the data extracted from the host message. Note that if the field contains message flags, they will be overwritten, not updated.
- 65 Message type 65** (ASCII A) updates the Offset Angle parameter with the data extracted from the host message. Syntax for the transmitted string is $\pm n$ where \pm is a positive or negative sign and n is an integer that represents the offset angle for the marking window.
- 72 Message type 72** (ASCII H) updates the Offset X/Y parameters with the data extracted from the host message. Syntax for the transmitted string is $\pm X.X, \pm Y.Y$ where \pm is a positive or negative sign, $X.X$ represents the X-axis offset distance, and $Y.Y$ represents the Y-axis offset distance.
- 80 Message type 80** (ASCII P) indicates the data extracted from the host message is the name of the pattern to be loaded.
- 81 Message type 81** (ASCII Q) updates the text in the first query text buffer (buffer 0) with the data extracted from the host message.
- 86 Message type 86** (ASCII uppercase V) updates the text in the first variable text field in the pattern with the data extracted from the host message.
- 118 Message type 118** (ASCII lowercase v) updates the first text field encountered in the pattern that contains a variable text flag that matches the specified string length.
- 0 Message type 0** (zero) indicates that host will provide message type, field number (if applicable), and data;. This delegates message type selection to the host on message-by-message basis. The host message must use the format:
Tnn<string>
where:
T = the message type (1, A, H, P, Q, V, or v)
nn = the two-digit field number or query text buffer where data will be placed.
Note: Not used with Message Types A, H, P.
<string>= the pattern name to load (Message Type P).
or
the data to be inserted into the field or the query text buffer, as applicable (Message Types 1, Q, V, or v).

EY6DS Laser Marking System

Communications Protocol (continued)

Extended Protocol. Extended protocol provides two-way communication with error checking and transmission acknowledgment. It is designed to provide secure communications with an intelligent host device using pre-defined message formats and response formats where serial communication is a vital part of the marking operation.

All communications are carried out in a parent/child relationship with the host being the parent. Only the host has the ability to initiate communications. The following describes the Extended Protocol message format as sent from the host to the Merlin II LS software

SOH TYPE [##] STX [DATA] ETX BCC CR

where:

SOH ASCII Start of Header character (001H). The system ignores all characters received prior to the SOH.

TYPE A single, printable ASCII character that defines the meaning (type) and content of the message downloaded from the host, where:

- 1** **Message Type 1** provides data to a text string in the pattern or polls the pattern for data. See [DATA] for details.
- A** **Message Type A** provides data to the system Offset Angle parameter for the marking window or polls the system for data. See [DATA] for details.
- E** **Message Type E** allows the host to take the machine offline. It also provides the option of displaying an error message box with the provided data string. See [DATA] for details.
- G** **Message Type G** initiates a print cycle.
- H** **Message Type H** provides data to the system X/Y Offset parameters or polls the system for data. See [DATA] for details.
- I** **Message Type I** polls the system for the I/O status.
- O** **Message Type O** places the marker online. This allows a host computer to reset. For example, this may be used to recover from a power outage when the marker is unattended.
- P** **Message Type P** loads a pattern or polls the system for the current pattern name. See [DATA] for details.
- Q** **Message Type Q** provides data to the system query text buffer or polls the system for data. See [DATA] for details.
- S** **Message Type S** polls the system for the machine status. The machine status is returned to the host in an eight-character hexadecimal mask.
- V** **Message Type V** provides data to a variable text string in the pattern or polls the pattern for data. See [DATA] for details.

[##] Optional two-digit ASCII number that specifies the Station ID of the system in multi-drop network applications. The ID may range from 00-31. Note that "00" is reserved for applications where only one controller is used. In such applications, this field may be eliminated and "00" will be assumed.

STX ASCII Start of Text Character (002H).

[DATA] Character string that may be required for certain message types (e.g., Type 1, A, E, H, P, Q, or V).

Typically, data is sent in the format:

nn<string>

where:

nn = the two-digit field number or query text buffer where data will be placed. (Message Types 1, Q, or V).

<string> = the data to be inserted into the field or the query text buffer, as applicable (Message Types 1, Q, or V).

or

the pattern name to load (Message Type P).

or

the value of the X/Y Offset (Message Type H).

or

the value of the Offset Angle (Message Type A).

ETX ASCII end of text character (003H).

BCC Optional Block Check Code that is generated and sent to improve link reliability by providing fault detection. The BCC is calculated by taking an eight bit addition of the TYPE and DATA TEXT characters and transmitting them as a three digit ASCII decimal number in the range from 000 to 255. If the sum is greater than 255, the most significant bit overflows and is discarded.

CR ASCII Carriage Return Character (00DH)

TRADEMARKS

Telesis and **Merlin** are registered trademarks of Telesis Technologies, Inc. in the United States and/or other countries.

Pentium is a registered trademark of Intel Corporation in the United States and other countries.

Windows and **Vista** are registered trademarks of Microsoft Corporation in the United States and other countries.